

CANopen スレーブユニット
ハードウェアマニュアル
CANopen Slave Unit
Hardware Manual



Preface

Thank you for purchasing Pro-face's "CA9-CANALL/EX01" CANopen Slave Unit (hereafter referred to as the "CANopen Slave Unit") .

This product is designed to be used as an expansion unit for the GP3000 series *1 (hereafter referred to as "GP") when performing CANopen communications with GPs.

Before actually beginning to use this product, please be sure to read through this manual and other related manuals to fully understand all the settings and functions.

*1 Does not include the GP-3200 series and the CANopen board type unit of the GP3000 series.

NOTICE

1. Copying this manual's contents, either in whole or in part, is prohibited without the express permission of Digital Electronics Corporation, Japan.
2. The information contained in this manual is subject to change without notice.
3. If you should find any errors or omissions in this document, please contact Digital Electronics Corporation to report your findings.
4. Regardless of Clause 3 above, Digital Electronics Corporation shall not be held responsible for any damages, losses or third-party damages resulting from the use of this product.

© Copyright 2009 Digital Electronics Corporation. All rights reserved.

Product names used in this manual are the trademarks/registered trademarks of their respective owners.

CANopen is a registered trademark of CiA (CAN in Automation).





Essential Safety Precautions

This manual contains safety symbols which are designed to help the user use the CANopen Slave Unit correctly and safely. Before using this product, please be sure to read through this manual and other related manuals in order to gain a thorough understanding of this product's operation methods and functions.



Safety symbols

In order to use the CANopen Slave Unit safely, the following safety symbols are used to indicate safety precautions in this manual. The safety precautions shown here contain important safety related information.

Safety symbols and their meanings are described below.



 WARNING	Indicates content that may cause serious injuries or death if this symbol is ignored and this product is handled in an incorrect manner.
 CAUTION	Indicates content that may cause injuries or property damage if this symbol is ignored and this product is handled in an incorrect manner.
	Indicates prohibited items that must not be performed in order to use this product correctly.
	Indicates compulsory items that must be performed in order to use this product correctly.

WARNING

-  Always turn the GP power supply off before installing the CANopen Slave Unit in order to avoid possible electric shocks.
-  Be sure to design your system so that a communication fault between GP and external device (PLC etc.) will not cause equipment to malfunction. This is to prevent any possibility of bodily injury or equipment damage.
-  Do not modify the CANopen Slave Unit. Modifications may lead to fires and electric shocks.

CAUTION

General Safety Precautions

-  Do not allow water, other liquids, and metal objects to enter the inside of the CANopen Slave Unit's case as these may cause a malfunction and electric shocks.
-  Avoid storing or operating the CANopen Slave unit in locations where it will be exposed to direct sunlight, high temperature, excessive dust, or vibration.
-  Avoid storing or operating the CANopen Slave unit in locations where it would be exposed to excessive temperature and dew condensation happens.



- ⊘ Do not store or operate the CANopen Slave unit where chemicals or acids are stored, or where high concentrations of fumes are present.
- ⊘ Because the CANopen Slave unit is a precision instrument, do not store or operate it in locations where something may strike or hit the unit.
- ⊘ Do not clean the CANopen Slave Unit using paint thinner or organic solvents. Remove contamination using a tightly wrung soft cloth lightly soaked in diluted neutral detergent.

Unit Disposal

- ⚠ When the product is disposed of, it should be treated as industrial waste products. Therefore, you are requested to obey the disposal standards or regulations of your country.

Information Symbols

This manual uses the following icons:

	Indicates a warning or a product limitation. Be sure to follow the instructions given with this icon to ensure the safe operation of the CANopen Slave unit.
	Contains additional or useful information.
(1) (2)	Operating procedure. Carry out operations in the order shown by the numbers.
*	Indicates useful or important supplemental information.
	Indicates pages containing related information.
Connected device	Indicates the master station (PLCs, etc.) which performs GP and CANopen communications.
GP-Pro EX	Indicates the screen editor program for Pro-face's GP3000 series.

Package Contents

- CANopen Slave Unit (1)
- Hardware manual (this manual) (1)

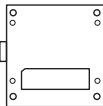

- Warning/Caution Information (1)
- Mounting screws (4)

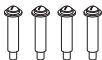

This unit has been carefully packed, with special attention to quality. However, if you find anything damaged or missing, please contact your Pro-face local distributor immediately.

Inquiry

Do you have any questions about difficulties with this product?

Please access Pro-face website anytime that you need help with a solution.

<http://www.pro-face.com/otasuke/>

Installation prerequisites for standards

The CANopen Slave unit "CA9-CANALL/EX-01" is a UL/c-UL product, listed on UL File No.E220851 and UL File No.E182139.

The CANopen Slave unit "CA9-CANALL/EX-01" is a UL/c-UL product, recognized on UL File No.E171486 and UL File No.E231702.

Product model no.	UL/c-UL registration model no.
CA9-CANALL/EX-01	3710014-01

The "CA9-CANALL/EX-01" CANopen Slave Unit conforms to the following standards:

- UL508
Standard for Industrial Control Equipment
- UL60950-1
Information Technology Equipment - Safety - Part 1
- ANSI/ISA-12.12.01
Nonincendive Electrical Equipment for Use in Class I, Division2
Hazardous (classified) Locations.

- CSA-C22.2 No.142-M1987 (c-UL Approval)
Standard for Process Control Equipment
- CSA-C22.2 No.213-M1987 (c-UL Approval)
Non-incendive Electrical Equipment for Use in Class I, Division 2
Hazardous Locations
- CAN/CSA C22.2 No.60950-1-03 (c-UL Approval)
Information Technology Equipment - Safety - Part 1

<Cautions>

Be aware of the following items when building the GP into an end-use product:

- Be sure that the unit is installed so that it is at least 100 mm (3.94 in.) away from any adjacent structures or devices. If these requirements are not met, the heat generated by the unit's internal components may cause the unit to fail to meet UL standard requirements.
- This unit has been evaluated for conformity to standards in combination with models 3280007-01, -02, -03, -12, -13, -24; 3280024-02, -14, -22, -32; 3280035-01, -02, -31, -41; and 3710011-01, 02.
- This unit has been evaluated for conformity to standards in combination with models 3280024-01, -11, -13, -21; 3280035-45, -75; and 3581301-01, -03.

<Hazardous Locations – Compliance and Handling Cautions>

- Suitable for use in Class I, Division 2, Groups A, B, C, and D Hazardous Locations, or Non-Hazardous Locations only.
- WARNING: Explosion hazard - substitution of any components may impair suitability for Class I, Division 2.
- WARNING: Explosion hazard - when in hazardous locations, turn off power before replacing or wiring modules.
- WARNING: Explosion hazard - do not disconnect equipment unless power has been switched off or the area is known to be non-hazardous.

CE Marking

The “CA9-CANALL/EX-01” CANopen Slave Unit is a CE marked product that conforms to the EMC directives EN55011 Class A and EN61000-6-2.

Contents

Preface	1
Essential Safety Precautions	2
Information Symbols	3
Package Contents	4
Inquiry	4
Installation prerequisites for standards	4
CE Marking	5
Contents	6
Chapter 1 Outline	
1.1 How the CANopen Slave Unit Works.....	7
1.2 System Configuration	7
1.2.1 Connection Configuration Diagram	7
1.3 Part Names and Functions	8
1.4 Software.....	9
Chapter 2 Specifications	
2.1 General Specifications	10
2.1.1 Electrical Specifications.....	10
2.1.2 Environmental Specifications	10
2.1.3 Structural Specifications	11
2.2 CANopen Specifications	12
2.2.1 CANopen Interface.....	12
2.2.2 CANopen Data Transfer Settings.....	12
2.3 Dimensions	13
2.3.1 Dimensions.....	13
Chapter 3 Installation	
3.1 Installing the CANopen Slave Unit.....	14
3.2 Wiring.....	16
3.2.1 CANopen Communication Cables and Other Recommended Items.....	16
3.2.2 CANopen Cable Arrangement.....	17
3.2.3 Wiring Precautions	18
After-sales service	

Chapter 1 Outline

1.1 How the CANopen Slave Unit Works

By attaching a CANopen Slave Unit to a GP and connecting a cable, GP and CANopen compatible PLCs or personal computers can be directly connected. Compatible models are shown below.

Host (Master)	Connecting cable	I/F module (Slave)	GP Type
CANopen master compatible PLCs or personal computers	Refer to "3.2 Wiring".	CANopen Slave Unit (CA9-CANALL/EX-01)	GP3000 series ^{*1}



^{*1} Does not include the GP-3200 series and the CANopen board type unit of the GP3000 series.

1.2 System Configuration

1.2.1 Connection Configuration Diagram

Carry out connections using a method that conforms with CANopen communication protocols. A diagram of a connection example is shown below.

CANopen (master) compatible personal computer or PLC

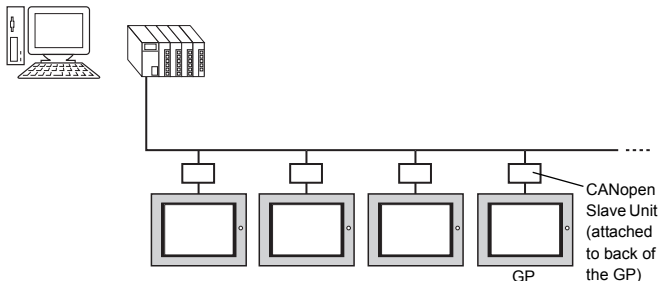

1.3 Part Names and Functions

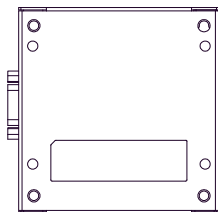

Front

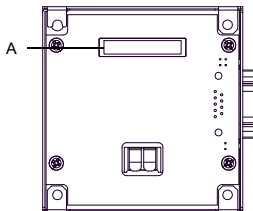

Back

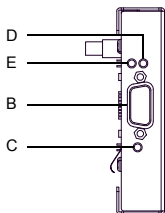

Left Side

A. GP connector

Connector for connecting the CANopen Slave Unit to the expansion unit interface of GP.

B. CANopen interface

Interface to connect CANopen Slaves.

C. PWR LED

D. RUN LED

E. ERR LED

LED names	Color	Status	Description
PWR	Green	ON	Power is ON.
		OFF	Power is OFF.
RUN	Green	Flashes once per second.	Communication STOPPED.
		Flashes three times and one second later flashes three times.	Initialization is in progress.
		ON	Normal Communication.
ERR	Red	OFF	Normal Communication.
		Flashes once per second.	Communication data error.
		Flashes twice and one second later flashes twice.	Check the node IDs and baud rates of the connected devices.
		ON	The connected device is not connected to the bus. (BUS is OFF)
		Flashing	The node ID address or communication settings are invalid.

1.4 Software

The CANopen Slave Unit is compatible with GP-Pro EX Ver.2.50 or later. If you are currently using Ver.2.50, it is necessary to download the latest module and install the additional programs.

For details, please visit Pro-face's support site "Otasuke Pro!".

<http://www.proface.com./otasuke/>

Refer to the "GP-Pro EX Device/PLC Connection Manual" for details related to communications settings.

Chapter 2 Specifications

2.1 General Specifications

2.1.1 Electrical Specifications

Item		Specifications
Power Supply	Rated Voltage	DC5V \pm 5% (Supplied by GP unit)
	Power Consumption	2.4W (max.)
Voltage Endurance		DC type GP: AC1000V 20mA for 1 minute (between charging and FG terminals) AC type GP: AC1500V 20mA for 1 minute (between charging and FG terminals)
Insulation Resistance		DC500V 10M Ω (min.) (between charging and FG terminals)

2.1.2 Environmental Specifications

Item		Specifications
Physical	Surrounding Air Temperature	0 to 50°C
	Storage Temperature	-20 to + 60°C
	Ambient Humidity	10% to 90% RH (Wet bulb temperature: 39°C max. - no condensation.)
	Storage Humidity	10% to 90% RH (Wet bulb temperature: 39°C max. - no condensation.)
	Dust	0.1mg/m ³ or less (non-conductive levels)
	Pollution Degree	For use in Pollution Degree 2 environment
	Atmosphere	Free of corrosive gas
Mechanical	Air Pressure Vibration Resistance (altitude range)	800 to 1114hPa (2000 meters max.)
	Vibration Resistance	Compliant with IEC61131-2 5 to 9Hz single-amplitude 3.5mm [0.14in.] 9 to 150Hz constant-accelerated velocity 9.8m/s ² X,Y,Z directions for 10 cycles (100 minutes)
	Impact Resistance	Compliant with IEC61131-2 (147m/s ² to three times each X, Y, Z direction)

Continued

Item		Specifications
Electrical	Noise Immunity (via noise simulator)	Noise Voltage: 1000 V _{P-P} (when using DC type GPs) 1500 V _{P-P} (when using AC type GPs) Pulse Duration: 1μs Rise Time: 1ns
	Electrostatic Discharge Immunity	Contact Electrical Discharge 6kV (complies with IEC61000-4-2 Level 3)

2.1.3 Structural Specifications

Item		Specifications
Installation	Installation Configuration	Screw mounted
	Cooling Method	Natural air circulation
	Weight Approx.	500g [1.1 lbs.] max. (Unit only)
	External Dimensions	W88.2 × H91 × D21.1mm [W3.47 × H3.58 × D0.83 in.] (excluding projections and connector parts)

2.2 CANopen Specifications

2.2.1 CANopen Interface

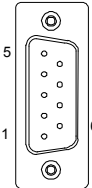
Connector (CANopen Slave Unit side)	XM2C-0942-502L <OMRON Co.>		
Recommended Cable Connector (Cable side)	See "3.2.1 CANopen Communication Cables and Other Recommended Items" on page 16.		
Interfit Bracket	#4-40 (UNC)		
Pin Arrangement		Signal Name	Description
 <p>(CANopen Slave Unit side)</p>	1	NC	Not connected
	2	CAN_L	CAN_L bus line
	3	CAN_GND	CAN ground
	4	NC	Not connected
	5	NC	Not connected
	6	NC	Not connected
	7	CAN_H	CAN_H bus line
	8	NC	Not connected
	9	NC	Not connected
Shell	FG	Frame Ground (Common with SG)	

2.2.2 CANopen Data Transfer Settings

CANopen is the networking standard based on the international standard CAN. CANopen is defined as a uniform application layer by the DS301 specifications of the CiA (CAN in automation).

Communication Type	1:N	
Connection Method	Bus	
Transfer Method	CSMA/NBA. Half-duplex serial transmission.	
Transmission Speed/ Communication Distance	Baud rate ^{*1}	Bus length
	1000 kbps	20 m
	800 kbps	40 m
	500 kbps	100 m
	250 kbps (factory setting)	250 m
	125 kbps	500 m
	50 kbps	1000 m
No. of Nodes ^{*1}	Node IDs: 1-127 PDO numbers: TPDO 64, RPDO 64	

^{*1} Set using software

2.3 Dimensions

2.3.1 Dimensions

Unit: mm [in.]

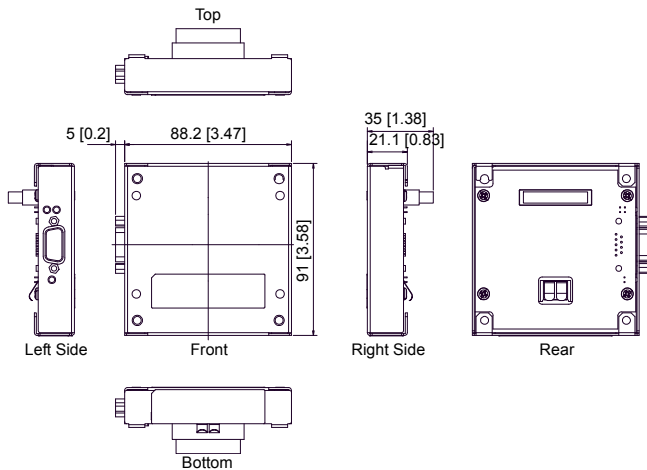

Chapter 3 Installation

3.1 Installing the CANopen Slave Unit

⚠ WARNING

- ❗ To prevent an electric shock, before installation be sure to check that the GP's power cord is not plugged in to a power supply.

The following figure describes how to install the CANopen Slave Unit to the AGP-3500T.

- (1) Disconnect the power cable from the GP and place the GP face down on a flat horizontal surface.
- (2) Insert the CANopen Slave Unit's GP connector into the expansion unit interface on the back of the GP.

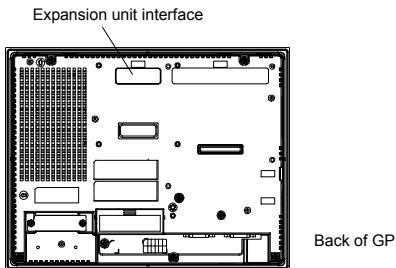

- (3) Fix the CANopen Slave Unit in place using the 4 screws supplied. (Tightening torque: 0.5 to 0.6N * m)

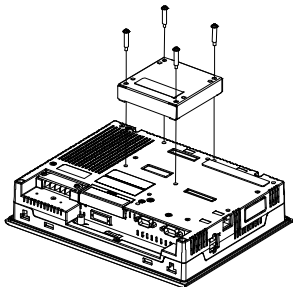

NOTE

- A connected cable will protrude from the back of the GP when the CANopen Slave Unit is attached to the GP-3300, 3400, 3500 or 3600 series.
(A connected cable will not protrude from the back of the GP-3700 series.)

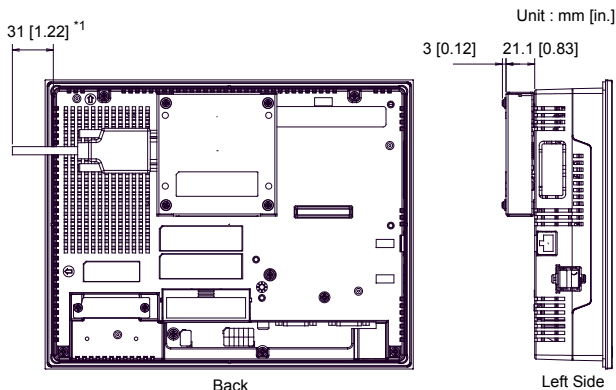

- *1 This value includes cable bends. However, this value will vary depending on the type of cable used. Please use this value as an approximation when designing systems.

Unit: mm [in.]

GP-3300 series	48 [1.89]
GP-3400 series	78 [3.07]
GP-3500 series	31 [1.22]
GP-3600 series	20 [0.79]

3.2 Wiring

⚠ CAUTION

- Always ground the FGs of connected devices (PLCs, etc.) in accordance with Class 3 ground standards. Please refer to the manuals of devices to be connected for details. Gather all cable shield wires and connect them to the FG of the connected device (PLC, etc.).

IMPORTANT

- Please use only cables compatible with CANopen communication protocols for connections with CANopen Slave Units and CANopen related devices.

3.2.1 CANopen Communication Cables and Other Recommended Items

NOTE

- CANopen communication cables and cable connectors are not supplied with the CANopen Slave Unit. The user must prepare cables.

Recommended Cable Connector:

CiA recommended CANopen (CiA DR-303-1) compatible DSUB 9-pin connector (DIN41652).

CANopen Recommended Communication Cable:

CiA recommended CANopen (CiA DR-303-1) compatible shielded twisted pair cable.

NOTE

- When manufacturing your own cables and cable connectors, please ensure that they are used within the scope of your quality guarantee.

	Model No.	Manufacturer	Description
Recommended Cable Connector	XM3D-0921	OMRON Corporation	DSUB 9-pin socket
	TSXCANKCDF180T	Schneider Electric	Straight connector with terminal selector switch
	TSXCANKCDF90T TSXCANKCDF90TP	Schneider Electric	Right-angled connector with terminal selector switch

Recommended Cable Connector	VS-09-BU-DSUB/ CAN	PHOENIX CONTACT	Connector with terminal block and terminal selector switch
	SUBCON-PLUS-CAN/AX	PHOENIX CONTACT	Straight connector with terminal selector switch
	SUBCON-PLUS-CAN/PG SUBCON-PLUS-CAN	PHOENIX CONTACT	Right-angled connector with terminal selector switch
CANopen Recommended Communication Cable	TSX CAN CA50/TSX CAN CA100	Schneider Electric	CANopen cable (IEC60332-1) 50m/100m
	TSX CAN CB50/TSX CAN CB100	Schneider Electric	UL approved CANopen cable (IEC60332-2) 50m/100m

3.2.2 CANopen Cable Arrangement

The CANopen interface uses a DSUB 9-pin plug connector. The plug is assigned with CAN_H, CAN_L and CAN_GND connections. CAN_H and CAN_L are two physically different bus levels. CAN_GND is the common reference potential.

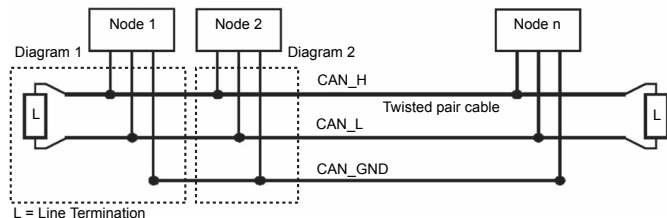

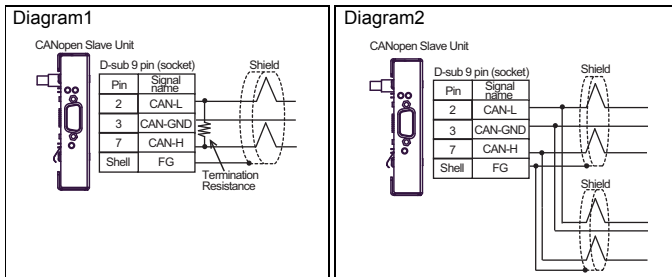
**NOTE**

- The cable's resistance value should be 70mΩ/m or less.
- The above diagrams use the "XM3D-0921" cable connector manufactured by OMRON Corporation.

■ Line termination

In order to minimize signal reflections from the ends of the cable, place line terminations close to both ends of the bus. Connect both ends of the twisted pair cable (CAN_H and CAN_L) to each GP. Use line terminations with resistance values of 120Ω (5%, 1/4W maximum).

3.2.3 Wiring Precautions

To help prevent noise and interference problems, separate all control, communication and power lines by placing them in separate ducts.

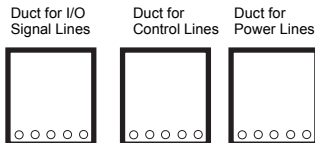

If different wires must be placed in the same duct, separate them using grounded dividers.

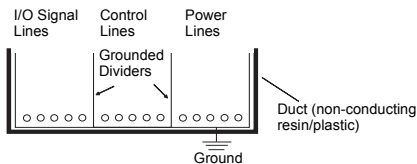
**NOTE**

- If the lines cannot be separated, use shielded cables and ground the ends of the shield wires.

IMPORTANT

- Use noise-reducing external wiring methods to increase overall system reliability.
- To prevent power surges or noise interference, use ducts to separate all DC I/O or current circuit wires from communication cables.
- To prevent malfunctions due to noise, communication cables must be wired separately from high-frequency lines and power lines such as high-voltage lines, high-current lines, and inverters.

After-sales service

For details on after-sales service, refer to Pro-face website at <http://www.pro-face.com/trans/en/manual/1001.html>