

CC-Link ユニット
インテリジェントデバイス局
ハードウェアマニュアル
CC-Link Unit
Intelligent Device Station
Hardware Manual



Preface

Thank you for purchasing the CC-Link unit “CA7-CCLALL/EX-01” (hereafter referred to as the “CC-Link unit”).

This unit is intended for use with expansion unit interface of the Pro-face's GP3000 series*¹ programmable operator interface (hereafter referred to as the “GP”), and as an interface between the CC-Link data network and any of the above mentioned GPs.

Before actually beginning to use the CC-Link unit, please be sure to read through this manual and other related manuals to fully understand all the settings and functions.

NOTE

- The CC-Link unit is compatible with up to CC-Link Ver. 2.0.

*¹Excluding the GP-3200 series.

NOTICE

1. Copying this manual's contents, either in whole or in part, is prohibited without the express permission of Digital Electronics Corporation, Japan.
2. The information contained in this manual is subject to change without notice.
3. If you find any errors or omissions in this document, please contact Digital Electronics Corporation to report your findings.
4. Regardless of those above, Digital Electronics Corporation shall not take responsibility for any damage, losses or third-party's damage resulting from the use of this product.

© 2007 Digital Electronics Corporation. All rights reserved.

Product names used in this manual are the trademarks / registered trademarks of their respective owners.





CC-Link is a registered trademark of Mitsubishi Electric Corporation.

Essential Safety Precautions



All safety-related procedures stated in this document must be followed to operate the CC-Link unit correctly and safely. Be sure to read this and any related documents thoroughly to understand the correct operation and functions of the CC-Link unit.

Safety Icons

Throughout this manual, these icons provide essential safety information for CC-Link unit operation procedures requiring special attention. These icons indicate the following levels of danger:

 WARNING	Indicates situations where severe bodily injury, death or major equipment damage can occur.
 CAUTION	Indicates situations where slight bodily injury or minor equipment damage can occur.
	Indicates actions or procedures that should NOT be performed.
	Indicates actions or procedures that MUST be performed to ensure correct unit operation.

WARNING

-  Due to the possibility of an electrical shock, be sure that the power supply for the GP is not plugged in when installing the CC-Link unit.
-  Be sure to design your system so that a communication fault between GP and external device (PLC etc.) will not cause equipment to malfunction. This is to prevent any possibility of bodily injury or equipment damage.
-  Do not modify the CC-Link unit. Doing so may cause a fire or an electric shock.

CAUTION

General Safety Precautions

-  Do not allow water, liquids, or metal particles to enter into the CC-Link unit's case, otherwise it can cause a malfunction or electrical shock.



- ⊘ Avoid storing or operating the CC-Link unit in locations where it will be exposed to direct sunlight, high temperature, excessive dust, or vibration.
- ⊘ Avoid storing or operating the CC-Link unit in locations where it would be exposed to excessive temperature and dew condensation happens.
- ⊘ Do not store or operate the CC-Link unit where chemicals or acids are stored, or where high concentrations of fumes are present.
- ⊘ Because the CC-Link unit is a precision instrument, do not store or operate it in locations where something may strike or hit the unit.
- ⊘ Do not use paint thinner or organic solvents to clean the outside of the CC-Link unit. Instead, soak a soft cloth in a diluted neutral detergent, wring it tightly, and then wipe the unit's outside case.

Unit Disposal

- ⓘ When the product is disposed of, it should be treated as industrial waste products. Therefore, you are requested to obey the disposal standards or regulations of your country.

Information Symbols

This manual uses the following icons:

	Indicates a warning or a product limitation. Be sure to follow the instructions given with this icon to ensure the safe operation of the CC-Link unit.
	Contains additional or useful information.
(1) (2)	Indicates steps used to accomplish a given task. Be sure to follow these steps in the order they are written.
*1	Indicates useful or important supplemental information.
	Indicates pages containing related information.
External Device	Indicates the CC-Link-DP Master station (PLC etc.), which connects a GP with CC-Link unit.
GP-Pro EX	Indicates the Screen editor program for Pro-face's GP3000 series.

Package Contents

CC-Link Unit (1)

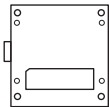

Hardware Manual <This Manual> (1)

Terminal block cover (1)

Connector terminal block (1)
(Unit attached)

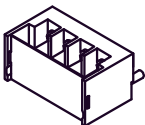

Screws (4)

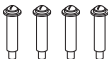

This unit has been carefully packed, with special attention to quality. However, should you find anything damaged or missing, please contact your local distributor immediately for service.

Inquiry / After-sales service

Do you have any questions about difficulties with this product ?

Please access Pro-face website anytime that you need help with a solution.

<http://www.pro-face.com/trans/en/manual/1001.html>.

Installation prerequisites for standards

The CC-Link unit "CA7-CCLALL/EX-01" is a UL/c-UL product, listed on UL File No.E220851 and UL File No.E182139.

The CC-Link unit "CA7-CCLALL/EX-01" is a UL/c-UL product, recognized on UL File No.E171486 and UL File No.E231702.

Product Model No.	UL/c-UL Registration Model No.
CA7-CCLALL/EX-01	3680301

This product conforms to the following standards:

- UL508
Standard for Industrial Control Equipment
- UL60950-1
Information Technology Equipment - Safety - Part 1

- ANSI/ISA-12.12.01
Nonincendive Electrical Equipment for Use in Class I, Division 2 and Hazardous (classified) Locations.
- CSA-C22.2 No.142-M1987 (c-UL Approval)
Process Control Equipment
- CSA-C22.2 No.213-M1987 (c-UL Approval)
Non-incendive Electrical Equipment for Use in Class I, Division 2 Hazardous Locations
- CAN/CSA C22.2 No.60950-1-03 (c-UL Approval)
Information Technology Equipment - Safety - Part 1

<Cautions>

Be aware of the following items when building the GP into an end-use product:

- Be sure that the unit is installed so that it is at least 100 mm away from any adjacent structures or devices. If these requirements are not met, the heat generated by the unit's internal components may cause the unit to fail to meet UL standard requirements.
- For use with the following models only: Models 3280007-01, -02, -03, -12, -13, -24; 3280024-02, -14, -22, -32; 3280035-01, -02, -31, -41.
- For use with the following models only: Models 3280024-01, -11, -13, -21; 3280035-45, -75; 3581301-01, -03.

<Hazardous Locations - Compliance and Handling Cautions>

- Suitable for use in Class I, Division 2, Groups A, B, C, and D Hazardous Locations, or Non-Hazardous Locations.
- WARNING: Explosion hazard - substitution of any components may impair suitability for Class I, Division 2.
- WARNING: Explosion hazard - when in hazardous locations, turn off power before replacing or wiring modules.
- WARNING: Explosion hazard - do not disconnect equipment unless power has been switched off or the area is known to be non-hazardous.

CE Marking

The CC-Link unit "CA7-CCLALL/EX-01" is CE marked product that conforms to EMC directives, EN55011 Class A and EN61000-6-2.

Contents

Preface	1
Essential Safety Precautions	2
Information Symbols	3
Package Contents	4
Inquiry / After-sales service	4
Installation prerequisites for standards	4
CE Marking	5
Contents	6
Chapter 1 General	
1.1 Operating the CC-Link Unit	7
1.2 System Configuration	7
1.2.1 Connection Configuration Diagram	7
1.2.2 Number of Connected Units	8
1.2.3 Transmission Distance	10
1.3 Parts Name and Functions	13
1.4 Software	14
Chapter 2 Specifications	
2.1 General Specifications	15
2.1.1 Electrical	15
2.1.2 Environmental	15
2.1.3 Structural	16
2.2 Performance Specifications	17
2.2.1 Performance Specifications	17
2.3 External Views and Dimensions	19
2.3.1 External Views	19
Chapter 3 Installation	
3.1 Installing the CC-Link Unit	20
3.2 Wiring for CC-Link-DP	21
3.2.1 Recommended Cables	21
3.2.2 Wiring	21

Chapter 1 General

1.1 Operating the CC-Link Unit

The CC-Link unit installed on the GP enables a direct cable connection between a CC-Link compatible PLC and the GP, which functions as an intelligent device station. The compatible models are shown below.

Host Computer (Master)	Connection Cable	I/F Module (Slave)	GP Type
CC-Link compatible master PLC's from different manufacturers	See "3.2 Wiring for CC-Link-DP"	CC-Link unit (CA7-CCLALL/EX-01)	GP3000 Series *1

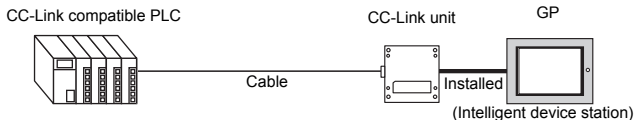

*1 Excluding the GP-3200 series

1.2 System Configuration

1.2.1 Connection Configuration Diagram

An example of connections for an entire CC-Link system is illustrated below.

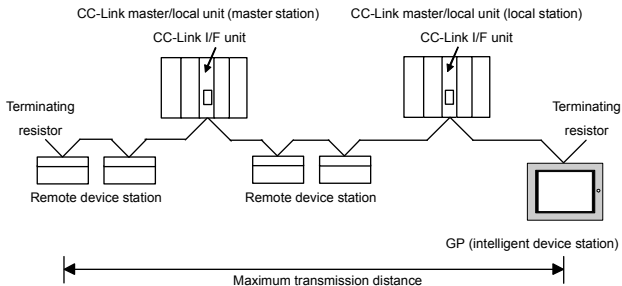

1.2.2 Number of Connected Units

The number of units connected to a master station must satisfy the following four conditions.

1	$\{(a+a2+a4+a8)+$ $(b+b2+b4+b8)\times 2+$ $(c+c2+c4+c8)\times 3+$ $(d+d2+d4+d8)\times 4\} \leq 64$	a: No. of single setting units with 1 station occupied (including Ver. 1.00 compatible station) b: No. of single setting units with 2 stations occupied (including Ver. 1.00 compatible station) c: No. of single setting units with 3 stations occupied (including Ver. 1.00 compatible station) d: No. of single setting units with 4 stations occupied (including Ver. 1.00 compatible station)
2	$\{(a\times 32+a2\times 32+a4\times 64+a8\times 128)+$ $(b\times 64+b2\times 96+b4\times 192+b8\times 384) +$ $(c\times 96+c2\times 160+c4\times 320+c8\times 640)+$ $(d\times 128+d2\times 224+d4\times 448+d8\times 896)\}$ ≤ 8192	a2: No. of double setting units with 1 station occupied b2: No. of double setting units with 2 stations occupied c2: No. of double setting units with 3 stations occupied d2: No. of double setting units with 4 stations occupied
3	$\{(a\times 4+a2\times 8+a4\times 16+a8\times 32)+$ $(b\times 8+b2\times 16+b4\times 32+b8\times 64) +$ $(c\times 12+c2\times 24+c4\times 48+c8\times 96)+$ $(d\times 16+d2\times 32+d4\times 64+d8\times 128)\}$ ≤ 2048	a4: No. of quadruple setting units with 1 station occupied b4: No. of quadruple setting units with 2 stations occupied c4: No. of quadruple setting units with 3 stations occupied d4: No. of quadruple setting units with 4 stations occupied a8: No. of octuple setting units with 1 station occupied b8: No. of octuple setting units with 2 stations occupied c8: No. of octuple setting units with 3 stations occupied d8: No. of octuple setting units with 4 stations occupied

4	$\{(16 \times A) + (54 \times B) + (88 \times C)\} \leq 2304$	A: No. of remote I/O station units ≤ 64 units B: No. of remote device station units ≤ 42 units C: No. of local station and intelligent device station units ≤ 26 units
---	---------------------------------------------------------------	---------------------------------------------------------------------------------------------------------------------------------------------------------------------------------------------

The GP will function as an intelligent device station.

For example, when the GP's are connected to one master station only, a maximum of 26 units can be connected.

1.2.3 Transmission Distance

IMPORTANT

- Following two types of CC-Link dedicated cables are available. Please note that the transmission distance differs depending on the cable to use.

CC-Link Versions	Manufacturers	Models	Names
Ver.1.10	Kuramo Electric Co., Ltd.	FANC-110SBH	Dedicated cable ^{*1}
Ver.1.00	Kuramo Electric Co., Ltd.	FANC-SB	Dedicated cable ^{*1}
		FANC-SBH	Dedicated high-performance cable ^{*1}

^{*1} CC-Link dedicated cable and dedicated high-performance cable cannot be mixed to use.

- CC-Link Ver. 1.10 compatible cables are required to configure the system conforming to CC-Link Ver. 1.10/2.0 communications.
- CC-Link Ver. 1.10 compatible cables and Ver. 1.00 compatible cables can coexist on the same network. However, that system conforms to CC-Link Ver. 1.00.
- When using CC-Link Ver. 1.10 compatible cables, cables of different brands can be used. However, when using CC-Link Ver. 1.00 compatible cables, stick to one brand.
- For the T-Branch transmission, refer to the documentation that comes with the CC-Link master unit made by Mitsubishi Electric Corporation.

■CC-Link Ver. 1.10 Compatible Cables

- When using the CC-Link dedicated cable FANC-SB1 made by Kuramo Electric Co., Ltd. (using 110Ω terminating resistor)

Transmission speed	Inter-station cable length (1)(2)(3) ^{*1}	Maximum transmission distance
156kbps	0.2m (0.66ft) or longer	1200m (3936ft)
625kbps		900m (2952ft)
2.5Mbps		400m (1312ft)
5Mbps		160m (525ft)
10Mbps		100m (328ft)

- *1 (1): Inter-station cable length for remote I/O stations or remote device stations
 (2): Inter-station cable length for master stations
 (3): Inter-station cable length for local stations or intelligent device stations

SEE → Refer to "1.2.1 Connection Configuration Diagram"

■ CC-Link Ver. 1.00 Compatible Cables

- When using the CC-Link dedicated cable FANC-SB made by Kuramo Electric Co., Ltd. (using 110Ω terminating resistor)

Transmission speed	(1)*1	(2)(3)*1	Maximum transmission distance
156kbps	30cm (11.81in) or longer	2m (6.56ft) or longer	1200m (3936ft)
625kbps			600m (1968ft)
2.5Mbps			200m (656ft)
5Mbps	60cm (23.62in) or longer		150m (492ft)
	30 to 59cm (11.81 to 23.23in) or longer		110m (361ft)
10Mbps	1m (3.28ft) or longer		100m (328ft)
	60 to 99cm (23.62 to 38.98in)		80m (262ft)
	30 to 59cm (11.81 to 23.23in)		50m (164ft)

- When using the high-performance CC-Link dedicated cable FANC-SBH made by Kuramo Electric Co., Ltd. (using 130Ω terminating resistor)

Transmission speed	(1) ^{*1}		(2)(3) ^{*1}	Maximum transmission distance
156kbps	30cm (11.81in) or longer			1200m (3936ft)
625kbps				900m (2952ft)
2.5Mbps				400m (1312ft)
5Mbps				160m (525ft)
10Mbps	No. of connected units: 1 to 32		2m (6.56ft) or longer	100m (328ft)
				No. of connected units: 33 to 48
		30 to 39cm (11.81 to 15.35in)		
	No. of connected units: 49 to 64	70cm (27.56in) or longer		100m (328ft)
		40 to 99cm (15.75 to 38.98in)		30m (98ft)
		30 to 39cm (11.81 to 15.35in)		20m (66ft)

*1 (1): Inter-station cable length for remote I/O stations or remote device stations

(2): Inter-station cable length for master stations

(3): Inter-station cable length for local stations or intelligent device stations

SEE →

Refer to "1.2.1 Connection Configuration Diagram"

1.3 Parts Name and Functions

A. GP connector

For connection to the expansion unit interface of a GP unit.

B. CC-Link Connector terminal block

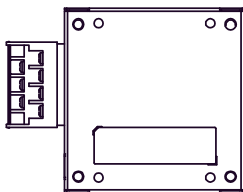

Front

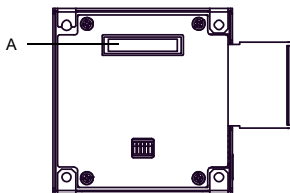

Rear

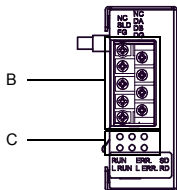

Left Side

Signal Name	Sheath Color	Pin No.	Description
DA	Blue	5	Transmission path A
DB	White	3	Transmission path B
DG	Yellow	1	Transmission path G
SLD	Shield	4	Shield
FG	-	2	Ground for signals
NC	-	6,7	No wire connection

C. LED

LED Name	Color	LED	Status
RUN	Green	ON	Unit normal
		OFF	Watchdog timer error
L RUN	Green	ON	Data link normal
		OFF	Communication disconnected (timeover error)
SD	Green	ON	Sending data
RD	Green	ON	Receiving data
L ERR	Red	ON	Communication data error (CRC error)
ERR	Red	ON	Station number mode setting error, redundant masters on the same line, parameter error, etc.
		Blinking	Data link error on another station

1.4 Software

CC-Link unit is compatible for GP-Pro EX Ver. 1.10.000 or later.

Depending on your software version, it is necessary to download the latest module and install the additional programs.

For details, please access Pro-face website that offers support for Pro-face products.

<http://www.pro-face.com/otasuke/>

For further detail of the communication setup, refer to “GP-Pro EX Device/PLC Connection Manual”.

Chapter 2 Specifications

2.1 General Specifications

2.1.1 Electrical

Items		Specifications
Power Supply	Rated Voltage	DC5V \pm 5%(supplied by the GP unit)
	Power Consumption	1.6W or less
Voltage Endurance		When the GP is DC type: AC1000V 20mA for 1 minute (between charging and FG terminals) When the GP is AC type: AC1500V 20mA for 1 minute (between charging and FG terminals)
Insulation Resistance		DC500V 10M Ω (min.) (between charging and FG terminals)

2.1.2 Environmental

Items		Specifications
Physical	Surrounding Air Temperature	0°C to 50°C
	Storage Temperature	-20°C to +60°C
	Ambient Humidity	10%RH to 90%RH (Wet bulb temperature: 39°C max. - no condensation.)
	Storage Humidity	10%RH to 90%RH (Wet bulb temperature: 39°C max. - no condensation.)
	Dust	Less than 0.1mg/m ³ and below (non-conductive levels)
	Pollution Degree	For use in Pollution Degree 2 environment
	Atmosphere	Free of corrosive gas
	Air Pressure Vibration Resistance (availability altitude)	800 to 1114hPa (2,000 meters above sea-level and below)

Mechanical	Vibration Resistance	Comply with JIS B 3502, IEC61131-2 5 to 9Hz single-amplitude 3.5mm 9 to 150Hz constant-accelerated velocity 9.8m/s ² X,Y,Z directions for 10 cycles (100 minute)
	Impact Resistance	Comply with JIS B 3502, IEC61131-2 (147m/s ² to twice X, Y, Z each directions)
Electrical	Noise Immunity (via noise simulator)	Noise Voltage: 1000V _{P-P} (GP:DC type) 1500V _{P-P} (GP:AC type) Pulse Duration: 1μs Rise Time: 1ns
	Electrostatic Discharge Immunity	Contact Electrical Discharge 6kV (complies with IEC61000-4-2 Level 3)

2.1.3 Structural

Items		Specifications
Installation	Installation method	Screw fixing
	Cooling Method	Natural air circulation
	Weight	Approx. 300g [0.7lb]
	External Dimensions	W88.4mm [3.48in.] x H91mm [3.58in.] x D35.1mm [1.38in.] (excluding projection and connector part)

2.2 Performance Specifications

2.2.1 Performance Specifications

Items			Specifications			
CC-Link station types			Intelligent device station			
Number of occupied stations			Selectable from 1 to 4 (selected via software)			
Extended cyclic setting			1 time setting	2 times setting*1	4 times setting*1	8 times setting*1
Number of link points per unit	1 station occupied	Remote input/output (RX/Ry)	32 points each	32 points each	64 points each	128 points each
		Remote resistors (RWw/RWr)	4 points each	8 points each	16 points each	32 points each
	2 stations occupied	Remote input/output (RX/Ry)	64 points each	96 points each	192 points each	384 points each
		Remote resistors (RWw/RWr)	8 points each	16 points each	32 points each	64 points each
	3 stations occupied	Remote input/output (RX/Ry)	96 points each	160 points each	320 points each	640 points each
		Remote resistors (RWw/RWr)	12 points each	24 points each	48 points each	96 points each
	4 station occupied	Remote input/output (RX/Ry)	128 points each	224 points each	448 points each	896 points each
		Remote resistors (RWw/RWr)	16 points each	32 points each	64 points each	128 points each

Items		Specifications
Maximum number of link points per system	CC-Link Ver. 2.00	Remote input/output (RX, RY): 8192 points in total Remote resistor (RWw, RWr): 2048 points each A write operation starts from master station to remote device station/local station/intelligent device station. A read operation proceeds in the reverse direction of write operation.
	CC-Link Ver. 1.10/1.00	Remote input/output (RX, RY): 2048 points in total Remote resistor (RWw, RWr): 256 points each A write operation starts from master station to remote device station/local station/intelligent device station. A read operation proceeds in the reverse direction of write operation.
Transmission speed		156Kbps/625Kbps/2.5Mbps/5Mbps/10Mbps
Maximum transmission distance		156Kbps : 1200m (3936ft) 625Kbps : 900m (2952ft) 2.5Mbps : 400m (1312ft) 5Mbps : 160m (525ft) 10Mbps : 100m (328ft) The inter-station cable length must be 20 cm (7.87 inch) longer when using CC-Link Ver. 1.10 cables regardless of the transmission speed. For the inter-station cable length for Ver. 1.00 cables, refer to "1.2.3 Transmission Distance".
Maximum number of connected units		26 units
Connection cable		CC-Link dedicated shielded twisted/twisted pair cable Refer to "3.2.1 Recommended Cables".

*1 Supported by CC-Link Ver. 2.00 only.

Chapter 3 Installation

3.1 Installing the CC-Link Unit

⚠ WARNING

- ❗ Due to the possibility of an electrical shock before installation, be sure the GP's power cord is not plugged in to the power supply.

The following figure describes how to install the CC-Link module into an AGP-3450T.

- (1) Disconnect the power cable and place the GP face down on a flat horizontal surface.
- (2) Insert the GP connector of the CC-Link unit into the Expansion Unit interface on the back of GP.

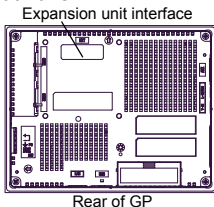

Rear of GP

- (3) Fix the CC-Link unit by four screws provided on CC-Link unit. (Tightening torque: 0.5 to 0.6 N•m)

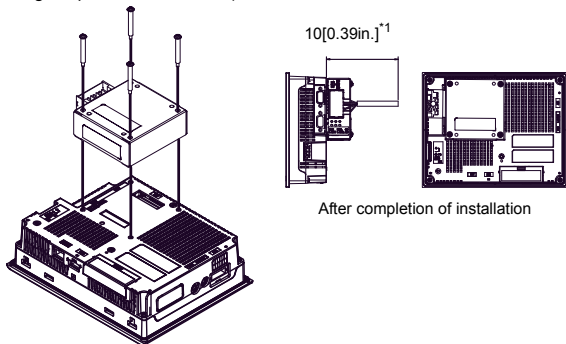

After completion of installation

*1 The value is designed in case of cable bending. The dimension given here is representative value depending on the type of connection cable used. Therefore, it is intended for reference only.

3.2 Wiring for CC-Link-DP

⚠ CAUTION

- ❗ Be sure to earth the FG of the external device (PLC etc.) according to Class 3 earthing standards. For details, please refer to the manual of the device/PLC used. Collect all the data cable's shield wires and connect them to the FG of the external device (PLC etc.).

IMPORTANT

- For connection of this unit and any equipment related to CC-Link, use special cables which comply with the CC-Link communication standards.

3.2.1 Recommended Cables

CC-Link Versions	Manufacturers	Models	Terminating resistors
Ver.1.10	Kuramo Electric Co., Ltd.	FANC-110SBH	110Ω
Ver.1.00	Kuramo Electric Co., Ltd.	FANC-SB	110Ω
		FANC-SBH	130Ω

IMPORTANT

- CC-Link Ver. 1.10 compatible cables are required to configure the system conforming to CC-Link Ver. 1.10/2.0 communications.

NOTE

- When CC-Link Ver. 1.00 compatible cables are used, the system must be configured in compliance with the CC-Link Ver. 1.00 specifications.

3.2.2 Wiring

- (1) Check that no power is supplied.
- (2) Remove the connector terminal block from the CC-Link unit.
Remove the terminal block cover and loosen the mounting screws (two places) of the connector terminal block alternately.

NOTE

- The fitting connector terminal block is OCN-2287-BRP-7P made by Osada Co., Ltd.

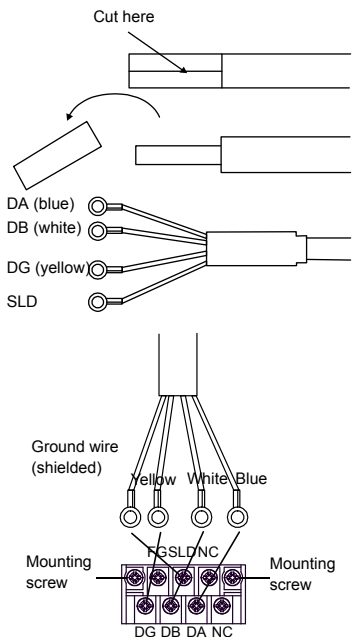

- (3) Cut the sheath of the cable.
- (4) Peel the sheath to expose the braided wires.
- (5) Crimp the cable wires using solderless terminals. Extend the shielded wire using an AWG18 thick wire rod, and cover it by taping or an insulating tube.
- (6) Connect the terminals to the connector terminal block.
- (7) Secure the wired connector terminal block to the CC-Link unit using the mounting screws at the two places. The tightening torque used is 0.8 N•m.

IMPORTANT

- Use a Phillips screwdriver to tighten the terminal screws (M3.5). The correct tightening torque is 0.8 N•m.

NOTE

- Do not solder the cable ends to the connector.
- Use copper conductor only.
- The temperature rating of the installed conductor is 80°C only.
- When the GP is connected at the end of a CC-Link network, connect a terminating resistor between DA and DB. A terminating resistor is bundled with the master unit used.