

Flex Network I/O Unit 16-point Input Sink • Source / 16-point Transistor Output Source Type Installation Guide

Thank you for purchasing Pro-face's "Flex Network I/O Unit 16-point Input Sink • Source / 16-point Transistor Output Source Type" (FN-XY16SC41) unit. To ensure correct use of this unit's functions and features, be sure to carefully read this installation guide and the Flex Network DIO Unit User Manual (downloaded from Pro-face's web site).

Safety Precautions

This guide contains a variety of safety markings for safe and correct operation of this unit. Please read this installation guide and any related manuals carefully to fully understand how to correctly use this unit's functions.

Safety Symbols

This guide uses the following symbols for important information related to the safe and correct operation of this unit. Please pay attention to these symbols and follow all instructions given. Safety symbols and their meanings:

	DANGER A hazardous situation that could result in serious injury or even death if instructions are not followed.
	WARNING A potentially hazardous situation that could result in serious injury or even death if instructions are not followed.
	CAUTION A potentially hazardous situation that could result in minor injury or equipment damage if instructions are not followed.

2 Specifications

Electrical (control section)

Rated Voltage	DC24V
Rated Voltage Range	DC20.4 to DC28.8V
Allowable Voltage Interruption	10ms or less (Power supply: DC24V)
Power Consumption	2.5W or less
Voltage Endurance	AC500V 10mA 1minute (between power/Input and Output, and FG terminals)
Insulation Resistance	DC500V at 10MΩ or higher (between power/Input and Output, and FG terminals)
In-rush Current	30A or less

Environmental

Ambient Operating Temperature	0°C to 55°C
Ambient Storage Temperature	-25°C to +70°C
Ambient Humidity	5% RH to 95% RH (non-condensing) (wet bulb temperature: less than 39°C)
Protection Rating	IP20
Pollution Level	Pollution Level 2

Input/Output

Input	Rated Input Voltage	DC24V
	Max. Input Voltage	DC28.8V
	No. of Input Points	16 points (sink/source type - dual use)
	Input ON Voltage	DC15V or higher
	Input OFF Voltage	DC5V or less
	Input Impedance	4.2kΩ
Input Delay Time	OFF-ON	1.5ms or less
	ON-OFF	1.5ms or less
Output	Rated Output Voltage	DC24V
	Rated Output Voltage Range	DC20.4V to DC28.8V
	No. of Output Points	16 points (source type)
	Maximum Load Voltage	0.2A/1 point(16 points/1 common, max. common current :1.6A)
	Output Protection	None
	Built-in Fuse	3.5A, DC125V built-in Chip Fuse (cannot be replaced)
	Voltage Drop (ON Voltage)	DC1.5V or less
	Clamp Voltage	DC39V ±1V
	Current Leakage	0.1mA or less
	Output Delay Time	OFF-ON 1ms or less ON-OFF 1ms or less
No. of Exclusive Use Nodes	1	

⚠ DANGERS

- An emergency stop circuit and an interlock circuit should be constructed outside of this unit. Constructing these circuits inside this unit may cause a runaway situation, system failure, or an accident due to unit failure.
- Systems using this unit should be designed so that output signals which could cause a serious accident are monitored from outside the unit.
- This unit is designed to be a general-purpose device for general industries, and is neither designed nor produced to be used with equipment or systems in potentially life-threatening conditions. If you are considering using this unit for special uses, including nuclear power control devices, electric power devices, aerospace equipment, medical life support equipment, or transportation vehicles, please contact your local Flex Network distributor.

⚠ WARNINGS

- Whenever installing, dismantling, wiring, and conducting maintenance or inspections, be sure to disconnect power to this unit to prevent the possibility of electric shock or fire.
- Do not disassemble or remodel this unit, since it may lead to an electric shock or fire.
- Do not use this unit in an environment that contains flammable gases since an explosion may occur.
- Do not use this unit in an environment that is not specified in either the Installation Guide or User Manual. Otherwise, an electric shock, fire, malfunction or other failure may occur.
- Because of the possibility of an electric shock or malfunction, do not touch any power terminals while the unit is operating.

⚠ CAUTIONS

- Communication cables or I/O signal lines must be wired separately from the main circuit (high-voltage, large-current) line, high-frequency lines such as inverter lines, and the power line. Otherwise, a malfunction may occur due to noise.
- This unit must be properly installed according to directions in the installation guide and user's manual. Improper installation may cause the unit to malfunction, or fail.
- This unit must be properly wired according to directions in the Installation Guide and User Manual. Improper wiring may cause a malfunction, failure or electric shock.
- Do not allow foreign substances, including chips, wire pieces, water, or liquids to enter inside this unit's case. Otherwise, a malfunction, failure, electric shock, or fire may occur.
- When disposing of this unit, handle it as industrial waste.

To Avoid Damage

- Avoid storing or operating this unit in either direct sunlight or excessively dusty or dirty environments.
- Because this unit is a precision instrument, do not store or use it in locations where excessive shocks or vibration may occur.
- Avoid covering this unit's ventilation holes, or operating it in an environment that may cause it to overheat.
- Avoid operating this unit in locations where sudden temperature changes can cause condensation to form inside the unit.
- Do not use paint thinner or organic solvents to clean this unit.

Package Contents

- Flex Network I/O Unit 16-point Input Sink • Source / 16-point Transistor Output Source Type (FN-XY16SC41)
- Flex Network I/O Unit 16-point Input Sink • Source / 16-point Transistor Output Source Type Installation Guide (this guide)

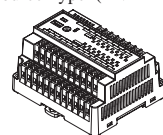

Installation
Guide

Driver & Manual

The driver for the Flex Network Unit is required in order to use the unit. For GLC2000 series and LT series, You can select the Flex Network Driver via GP-PRO/PBIII C-Package (Pro-Control Editor) or LT Editor. If the selection of the appropriate unit's name does not appear in the [I/O Configuration] - [I/O Unit Settings] area, you will need to update the driver file. You can download the latest driver from Pro-face's Home Page. For GP3000 Series, You can select the Flex Network Driver via GP-Pro EX as an I/O driver.

Also, you can download the driver and the Flex Network DIO Unit User Manual from Pro-face's web site. (<http://www.pro-face.com/>)

UL/c-UL (CSA) Application Notes

The FN-XY16SC41 is a UL/c-UL (CSA) recognized unit. (UL File No. E220851)

The FN-XY16SC41 unit conforms to the following standards.
 ■ UL508 Electrical Control System for Industry
 ■ CAN/CSA-C22.2 No.1010-1 (Safety requirements for electrical equipment for measurement, control and laboratory use)
 FN-XY16SC41 (UL Registration Model: 3080039-03)

<Notes>

- Only use the unit installed with other equipment.
- If the unit is installed in an area with no air conditioning system, be sure to install it in a vertical panel using a DIN rail or mounting holes. Also, be sure the unit is installed so it is at least 100 mm away from any adjacent structures or devices. If these requirements are not met, the heat generated by the unit's internal components may cause the unit to fail to meet UL standards requirements.
- The power supply unit connected to the I/O unit must be a UL/c-UL (CSA) approved Class 2 power supply unit or Class 2 transformer*1. When the GLC/LT/GP3000 or multiple I/O units under load are operated with a single power supply, the amount of current consumption and full-load current of the I/O units must be within the rated load of the Class 2 power supply unit or Class 2 power supply transformer. Be aware that the number of points which can be turned ON simultaneously may be limited, depending on the amount of load and load current value.

CE Marking Notes

The FN-XY16SC41 is a CE Marked unit that conforms to EMC directives EN55011 Class A and EN61000-6-2.

<Caution>

While this unit is officially marked as conforming to the relevant EMC directives, it is the user's final application of this unit in a larger system (i.e. the machinery, wiring, control panel, installation method, etc.) that will determine if this unit maintains or loses this conformance marking. Therefore, it is strongly advised that the user investigate and confirm whether their overall system (i.e. all related machinery and equipment) also conforms with these EMC directives.

*1 The National Electrical Code states that Class 2 power supplies and Class 2 transformers should not exceed an output of 30V, and at 8A or less, should not exceed 100VA.

4 I/O Unit Installation

Installing on a DIN rail:

This procedure installs the unit on a 35mm DIN rail.

Installation

Hook the I/O unit's top face groove over the top edge of the DIN rail. Next, push the bottom of the I/O unit forward until the attachment hook clicks into place on the DIN rail.

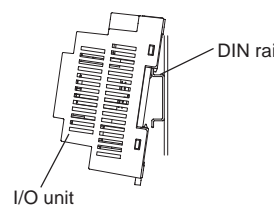

Removal

Use a screwdriver to push the attachment hook down and release the unit. Then, pull the unit forward and off the rail.

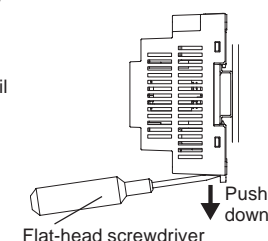

- Be sure that the top and bottom faces of the unit are facing the correct direction and the unit is installed in a vertical position. Incorrect installation may prevent heat from dissipating.
- The unit's attachment clip can be set to remain open. When attaching the unit, be sure to close the attachment clip completely and confirm that the I/O unit is set securely on the DIN rail.



The I/O unit can be attached to the rear of a GLC2300 Series unit or a GP-3300 Series unit. **Reference** Flex Network DIO Unit User Manual (downloaded from Pro-face web site)

3 Input/Output Circuit Connection Drawing

The drawing shows the connection between the input section and the source output type.

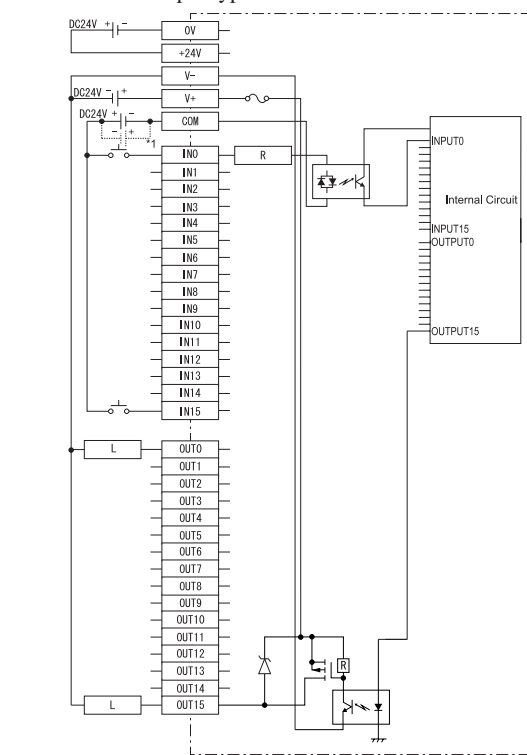

Note: The I/O unit's power supply should be separated from the sensor's power supply to prevent the unit from being affected by external noise.

*1 Dotted line shows the sink output connection.

1 External Dimensions / Part Names

This section shows the external dimensions of the I/O unit, part names and part settings. (Unit: mm/in.)

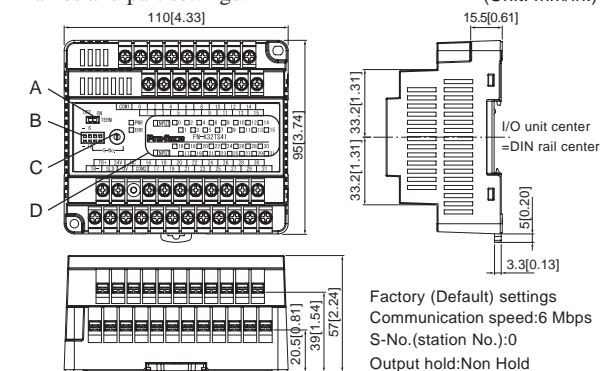

- A: Terminal Switch Changes termination ON/OFF. Turns ON only the unit connected at the end of the communication cable.
- B: Dip Switches Set communication speeds and S-No. (first digit).
- C: Rotary Switch Sets S-No.(station no.) (last digit).
- D: Status LED Indicates the unit's current operation status.

Switch Settings

OFF ... Termination OFF.
ON ... Termination ON

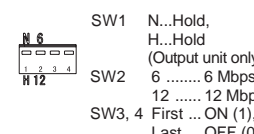

SW1 N...Hold, H...Hold (Output unit only)
6 6 Mbps, 12 12 Mbps
SW3, 4 First ... ON (1), Last ... OFF (0)

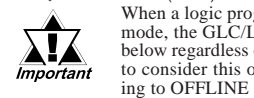

When a logic program switches from RUN mode to OFFLINE mode, the GLC/LT/GP3000 and I/O signals operate as shown below regardless of the output hold settings. Therefore, be sure to consider this operation before resetting the unit or switching to OFFLINE mode.

However, when performing Reset, the I/O signal OFF timing will change.

When preparing the cable wire ends:

- Cover shielded wires with shield tape or with an insulation tube.
- Use insulated crimp terminals.
- If you use a crimp-type terminal without insulation, cover it with a shield tape or an insulation tube. Cover uninsulated crimp terminals with shield tape or tube-type insulation.

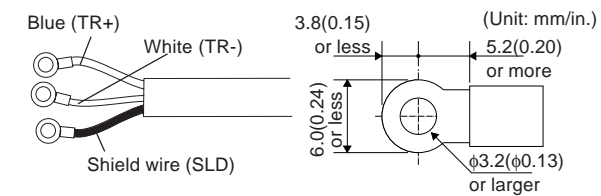

Power Cable

- Use as large a cable as possible (up to 1.25 mm²) and be sure to twist all wire ends before attaching crimp terminals.
- Use the same type crimp terminals as used for the communication cable.

I/O Cable

- Use a cable that is 0.5 to 1.25 mm² in diameter.
- Use the same type crimp terminals as used for the communication cable.



- Confirm that all I/O unit terminal screws are securely tightened, even if they are not used.
- Do not allow pieces of wire to fall inside the unit.

Note

Please be aware that Digital Electronics Corporation shall not be held liable by the user for any damages, losses, or third party claims arising from the uses of this product.

Head Office
Digital Electronics Corporation
 8-2-52 Nanko-higashi
 Suminoe-ku, Osaka 559-0031 JAPAN
 Tel: +81-(0)6-6613-1101 Fax: +81-(0)6-6613-5888
 URL: <http://www.pro-face.com/>

5 Wiring the I/O

This section describes both the cables and crimp terminals used for wiring each type of cable. The fastening torque for the terminal screws should be 0.3 to 0.5 N•m. For 2 terminals can be connected to a single terminal screw.

Flex Network Communication Cable

The Flex Network interface and the I/O unit, or all distributed I/O units, are connected using a cross wiring system. (T-type systems cannot be used.)

Use the following types of communication cables.

Distributor	Order Code	Length
Pro-face	FN-CABLE2010-31-MS	10m
	FN-CABLE2050-31-MS	50m
	FN-CABLE2200-31-MS	200m