

# Flex Network 2 Channel Digital/Analog Conversion Unit Installation Guide

Thank you for purchasing Pro-face's "Flex Network 2 Channel Digital/Analog Conversion Unit" (FN-DA02AH41). To ensure correct use of this unit's functions and features, be sure to carefully read both this installation guide and the Flex Network 2 Channel Analog Unit User Manual. The "Flex Network 2 Channel Digital/Analog Conversion Unit" (FN-DA02AH41) is a CE marked, UL/c-UL listed product.

## Safety Precautions

This guide contains a variety of safety markings for safe and correct operation of this unit. Please read this installation guide and any related manuals carefully to fully understand how to correctly use this unit's functions.

### Safety Symbols

This guide uses the following symbols for important information related to the safe and correct operation of this unit. Please pay attention to these symbols and follow all instructions given. Safety symbols and their meanings:

	<b>DANGER</b> A hazardous situation that could result in serious injury or even death if instructions are not followed.
	<b>WARNING</b> A potentially hazardous situation that could result in serious injury or even death if instructions are not followed.
	<b>CAUTION</b> A potentially hazardous situation that could result in minor injury or equipment damage if instructions are not followed.

## 2 Specifications

### Electrical (control section)

Rated Voltage	DC24V
Rated Voltage Range	DC20.4 to DC28.8V
Allowable Voltage Interruption	5ms or less (Power supply: DC24V)
In-rush Current	15A or less
Power Consumption	2.4W or less
Voltage Endurance	AC1,000V 10mA 1minute (between power input and output, and FG terminals) AC500V 10mA 1minute (between primary and secondary power supplies)
Insulation Resistance	10MΩ or more at DC500V (between charging and FG terminals)

### Environmental

Operating Temperature	0°C to 55°C
Storage Temperature	-25°C to +70°C
Operating Humidity	30% RH to 90% RH (non-condensing) Wet bulb temperature: less than 39°C
Storage Humidity	30% RH to 90% RH (non-condensing) Wet bulb temperature: less than 39°C
Pollution Degree	Pollution Degree 2
Protection Rating	IP30

### Output

Resolution	12 bit
Number of Output Channels	2ch
Conversion Time	up to 2 milliseconds
Output Range	0 to 10V (Impedance min. 10kΩ) 0 to 20mA (Impedance 10 to 500Ω)
Current / Voltage Switchover	4 to 20mA (Impedance 10 to 500Ω) <sup>*1</sup> Set via terminal connection location.
Accuracy	±1% / FS (0°C to 55°C) <sup>*2</sup>
Insulation Method	Photocoupler Insulation (output terminals / between internal circuits)
Conversion Timing	Simultaneous
No. of Exclusive Use Nodes	1

\*1 Converted via software.

\*2 This accuracy may not be possible if there is a large amount of noise.

## DANGERS

- An emergency stop circuit and an interlock circuit should be constructed outside of this unit. Constructing these circuits inside this unit may cause a runaway situation, system failure, or an accident due to unit failure.
- Systems using this unit should be designed so that output signals which could cause a serious accident are monitored from outside the unit.
- This unit is designed to be a general-purpose device for general industries, and is neither designed nor produced to be used with equipment or systems in potentially life-threatening conditions. If you are considering using this unit for special uses, including nuclear power control devices, electric power devices, aerospace equipment, medical life support equipment, or transportation vehicles, please contact your local Flex Network distributor.

## WARNINGS

- Whenever installing, dismantling, wiring, and conducting maintenance or inspections, be sure to disconnect power to this unit to prevent the possibility of electric shock or fire.
- Do not disassemble or remodel this unit, since it may lead to an electric shock or fire.
- Do not use this unit in an environment that contains flammable gases since an explosion may occur.
- Do not use this unit in an environment that is not specified in either the Installation Guide or User Manual. Otherwise, an electric shock, fire, malfunction or other failure may occur.
- Because of the possibility of an electric shock or malfunction, do not touch any power terminals while the unit is operating.

## CAUTIONS

- Communication cables or I/O signal lines must be wired separately from the main circuit (high-voltage, large-current) line, high-frequency lines such as inverter lines, and the power line. Otherwise, a malfunction may occur due to noise.
- This unit must be properly installed according to directions in the Installation Guide and User Manual. Improper installation may cause the unit to malfunction, or fail.
- This unit must be properly wired according to directions in the Installation Guide and User Manual. Improper wiring may cause a malfunction, failure or electric shock.
- Do not allow foreign substances, including chips, wire pieces, water, or liquids to enter inside this unit's case. Otherwise, a malfunction, failure, electric shock, or fire may occur.
- When disposing of this unit, handle it as industrial waste.

## To Prevent Unit Damage

- Avoid storing or operating this unit in either direct sunlight or excessively dusty or dirty environments.
- Because this unit is a precision instrument, do not store or use it in locations where excessive shocks or vibration may occur.
- Avoid covering this unit's ventilation holes, or operating it in an environment that may cause it to overheat.
- Avoid operating this unit in locations where sudden temperature changes can cause condensation to form inside the unit.
- Do not use paint thinner or organic solvents to clean this unit.

## Package Contents

- Flex Network 2 Channel Digital/Analog Conversion Unit (FN-DA02AH41)
- Flex Network 2 Channel Digital/Analog Conversion Unit Installation Guide (this guide)

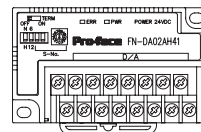

## Driver & Manual

The driver for the Flex Network Unit is required in order to use the unit.

For GLC2000 Series and LT Series,

You can select the Flex Network Driver via GP-PRO/PBIII C-Package (Pro-Control Editor) or LT Editor.

If the selection of the appropriate unit's name does not appear in the [I/O Configuration] - [I/O Unit Settings] area, you will need to update the driver file.

You can download the latest driver from Pro-face's Home Page.

For GP3000 Series,

You can select the Flex Network Driver via GP-Pro EX as an I/O driver.

Also, you can download the driver and the Flex Network 2 Channel Analog Unit User Manual from Pro-face's web site. (<http://www.pro-face.com/>)

## UL/c-UL Application Notes

The FN-DA02AH41 is a UL/c-UL listed product. (UL File No. E220851)

The FN-DA02AH41 unit conforms to the following standards.

- UL508 Electrical Control System for Industry
  - CAN/CSA-C22.2 No.1010.1-92. (c-UL recognition)
- Safety requirements for electrical equipment for measurement, control and laboratory use  
FN-DA02AH41 (UL Registration Model: 3380701-02)

<Notes>

- Only use the unit installed with other equipment.
- If the unit is installed in an area with no air conditioning system, be sure to install it in a vertical panel using a DIN rail or mounting holes. Also, be sure the unit is installed so it is at least 100 mm away from any adjacent structures or devices. If these requirements are not met, the heat generated by the unit's internal components may cause the unit to fail to meet UL standards requirements.
- The power supply unit connected to the Flex Network unit must be a UL/c-UL approved Class 2 power supply unit or Class 2 transformer<sup>\*1</sup>. When the GLC/LT/GP3000 or multiple Flex Network units under load are operated with a single power supply, the amount of current consumption and full-load current of the units must be within the rated load of the Class 2 power supply unit or Class 2 power supply transformer. Be aware that the number of points which can be turned ON simultaneously may be limited, depending on the amount of load and load current value.

## CE Marking Notes

The FN-DA02AH41 is a CE Marked unit that conforms to EMC EN55011 Class A and EN61000-6-2 directives.

<Caution>

While this unit is officially marked as conforming to the relevant EMC directives, it is the user's final application of this unit in a larger system (i.e. the machinery, wiring, control panel, installation method, etc.) that will determine if this unit maintains or loses this conformance marking. Therefore, it is strongly advised that the user investigate and confirm whether their overall system (i.e. all related machinery and equipment) also conforms with these EMC directives.

\*1 The National Electrical Code states that Class 2 power supplies and Class 2 transformers should not exceed an output of 30V and 8A, and should not exceed 100VA.

## 1 External Dimensions / Part Names

This section shows the external dimensions of the unit, part names and part settings. (Unit: mm[in.])

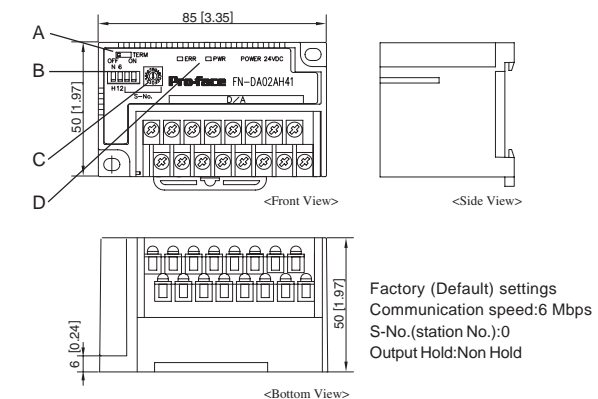

- A: Terminal Switch (TERM) ... Changes termination ON/OFF. Turns ON only the unit connected at the end of the communication cable.
- B: Dip Switches (S-No.) ..... Sets the output hold settings, communication speeds and station no. (first digit).
- C: Rotary Switch (S-No.) ..... Sets S-No.(station no.) (last digit).
- D: Status LED (ERR, PWR) .. Indicates the unit's current operation status.

◆ Switch Settings		◆ Examples of S-No. (station no.) settings		
TERM	ON/OFF	S-No.	Dip Switch SW3 SW4	Rotary Switch
OFF	Termination OFF	10h(16)	OFF(0) ON(1)	0
ON	Termination ON	3Fh(63)	ON(1) ON(1)	F

- When rotating the Rotary Switch, be sure to use a standard flat-blade screwdriver that is small enough to fit easily into the switch's slot. Also, using excessive force to turn the switch can damage the switch.

## 3 2 Channel Analog Unit Wiring

This section explains the Flex Network 2 Channel Digital/Analog Conversion Unit Connection and Circuit Drawings.

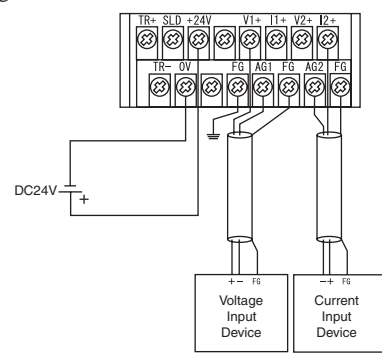

- Ch 1 output voltage terminals ..... V1+, AG1, FG
- Ch 1 output current terminals ..... I1+, AG1, FG
- Ch 2 output voltage terminals ..... V2+, AG2, FG
- Ch 2 output current terminals ..... I2+, AG2, FG

### Output Circuit Drawing

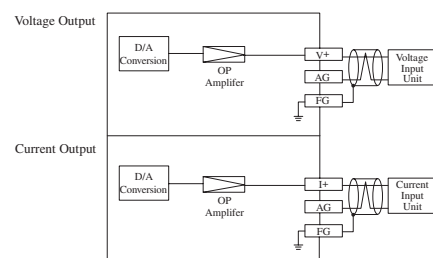

- The unit's power supply should be separated from the sensor's power supply to prevent the unit from being affected by external noise.
- All FG terminals are grounded internally.

## 4 Unit Installation

### Installing on a DIN rail:

This procedure installs the unit on a 35mm DIN rail.

#### Installation

Hook the unit's top face groove over the top edge of the DIN rail. Next, push the bottom of the unit forward until the attachment hook clicks into place on the DIN rail.

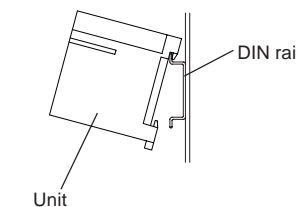

#### Removal

Use a screwdriver to push the attachment hook down and release the unit. Then, pull the unit forward and off the rail.

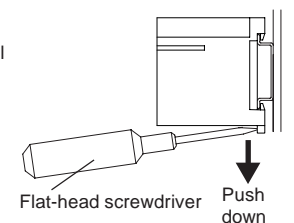

- Be sure that the top and bottom faces of the unit are facing the correct direction and the unit is installed in a vertical position. Incorrect installation may prevent heat from dissipating.

### Installing in a panel:

Drill attachment holes for installing the unit, using the dimensions given below. Secure the I/O unit in place with M4 size screws. The torque should be 1.0 to 1.3 N•m. (Unit: mm[in.])

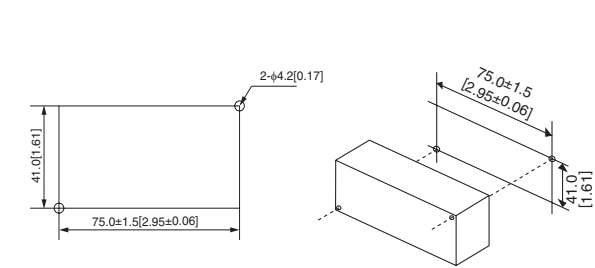

## 5 Wiring

This section describes both the cables and crimp terminals used for wiring each type of cable. The fastening torque for the terminal screws should be 0.6 to 1.0 N•m. 1or 2 terminals can be connected to a single terminal screw.

### Flex Network Communication Cable

The Flex Network interface and the Conversion unit, or all distributed I/O units, are connected using a cross wiring system. (T-type systems cannot be used.)

Use the following types of communication cables.

Distributor	Order Code	Length
Digital Electronics Corporation	FN-CABLE2010-31-MS	10m
	FN-CABLE2050-31-MS	50m
	FN-CABLE2200-31-MS	200m

When preparing the cable wire ends:

- Cover shielded wires with shield tape or with an insulation tube.
- Use insulated crimp terminals.
- If you use a crimp-type terminal without insulation, cover it with a shield tape or an insulation tube. Cover insulated crimp terminals with shield tape or tube-type insulation.

### Power Cable

- Use as large a cable as possible (up to 1.25 mm<sup>2</sup>) and be sure to twist all wire ends before attaching crimp terminals.
- Use the same type crimp terminals as used for the communication cable.

### Analog Output Cable

- Cable diameter can be up to 0.9mm<sup>2</sup> (CPEV-S f up to 0.9mm - co-axial, shielded)
- Use the same type crimp terminals as used for the communication cable.

- Confirm that all unit terminal screws are securely tightened, even if they are not used.
- Do not allow pieces of wire to fall inside the unit.

Note  
Please be aware that Digital Electronics Corporation shall not be held liable by the user for any damages, losses, or third party claims arising from the uses of this product.

Head Office  
**Digital Electronics Corporation**  
8-2-52 Nanko-higashi Suminoe-ku, Osaka 559-0031 JAPAN  
Tel: +81-(0)6-6613-1101 Fax: +81-(0)6-6613-5888  
URL: <http://www.pro-face.com/>