

Flex Network 4 Channel Analog/Digital Conversion Unit Installation Guide

Thank you for purchasing Pro-face's "Flex Network 4 Channel Analog/Digital Conversion Unit" (FN-AD04AH11). To ensure correct use of this unit's functions and features, be sure to carefully read both this Installation Guide and the Flex Network Analog Unit User Manual. Flex Network 4 Channel Analog/Digital Conversion Unit" (FN-AD04AH11) is not CE marked, UL/c-UL (CSA) listed products.

Safety Precautions

This guide contains a variety of safety symbols for safe and correct operation of this unit. Please read this installation guide and any related manuals carefully to fully understand how to correctly use this unit's functions.

Safety Symbols

This guide uses the following symbols for important information related to the safe and correct operation of this unit. Please pay attention to these symbols and follow all instructions given.

- Danger** A hazardous situation that will result in death or major equipment damage if instructions are not followed.
- Warning** A potentially hazardous situation that could result in death or major equipment damage if instructions are not followed.
- Caution** A potentially hazardous situation that could result in minor injury or equipment damage if instructions are not followed.

2 Specifications

Electrical (Control Section)

Rated Voltage	DC24V
Input Voltage	DC20.4 to DC28.8V
Allowable Voltage Drop	Up to 10ms (power supply: DC24V)
In-Rush Current	30A or less
Power Consumption	4.8W or less
Voltage Endurance	AC1500V 10mA 1minute (between input/output and FG terminals) AC500V 1minute (between power supply 1st level and 2nd level)
Insulation Resistance (via noise simulator)	10MΩ or more at DC500V (between charging and FG terminals)

Environmental

Ambient Operating Temperature	0°C to 55°C
Ambient Storage Temperature	-25°C to +70°C
Ambient Humidity	30% RH to 95% RH (non-condensation) level RH-1
Rating	IP30

Input

Resolution	12 bit
Number of Input Channel	4ch (fixed)
Conversion Time	up to 2 milliseconds
Input Range	0 to 5V (Impedance 1MΩ)
	1 to 5V (Impedance 1MΩ)
	0 to 10V (Impedance 1MΩ)
	-5 to 5V (Impedance 1MΩ)
	-10 to 10V (Impedance 1MΩ)
	0 to 20mA (Impedance 200Ω)
Input Range Switch	4 to 20mA (Impedance 200Ω)
	Depends on rotary switch settings
Calibration Function	Offset, Gain setting Setting the upper limit value / lower limit value for each range via switch
Accuracy	0.3% / FS (25°C) 0.5% / FS (0°C to 55°C)
Insulation Method	Photocoupler Insulation (input terminals / between internal circuits)
Processing (after conversion)	Simple Average, Running Average Exclude Max. / Min. values
Conversion Timing	Simultaneous - all channels (not selectable)

Danger

- An emergency stop circuit and an interlock circuit should be constructed outside of this unit. Constructing these circuits inside this unit may cause a runaway situation, system failure, or an accident due to unit failure.
- Systems using this unit should be designed so that output signals which could cause a serious accident are monitored from outside the unit.
- This unit is designed to be a general-purpose device for general industries, and is neither designed nor produced to be used with equipment or systems in potentially life-threatening conditions. If you are considering using this unit for special uses, including nuclear power control devices, electric power devices, aerospace equipment, medical life support equipment, or transportation vehicles, please contact your local Flex Network distributor.

Warning

- Whenever installing, dismantling, wiring, and conducting maintenance or inspections, be sure to disconnect power to this unit to prevent the possibility of electric shock or fire.
- Do not disassemble or modify this unit, since it may lead to an electric shock or fire.
- Do not use this unit in an environment that contains flammable gases since it may cause an explosion.
- Do not use this unit in an environment with conditions outside of the ranges specified in this Installation Guide and in the User Manual. Otherwise, an electric shock, fire, malfunction or other failure may occur.
- Because of the possibility of an electric shock or malfunction, do not touch the power terminals while the unit is operating.

Caution

- Communication cables or I/O signal lines must be wired separately from the main circuit (high-voltage, high-current) line, high-frequency lines such as inverter lines, and the power cord. Otherwise, a malfunction may occur due to noise.
- This unit must be properly installed according to directions in the Installation Guide and User Manual. Improper installation may cause the unit to malfunction, or operate incorrectly.
- This unit must be properly wired according to directions in the Installation Guide and User Manual. Improper wiring may cause a unit malfunction, failure or electric shock.
- Do not allow foreign substances, including chips, wire pieces, water, or liquids to enter inside this unit's case. Otherwise, a malfunction, failure, electric shock, or fire may occur.
- When disposing of this unit, it should be disposed of according to your country's industrial waste disposal laws.

3 4-Channel Analog Unit Wiring

This section explains the Flex Network 4 Channel Analog/Digital Conversion Unit Connection and Circuit Drawings.

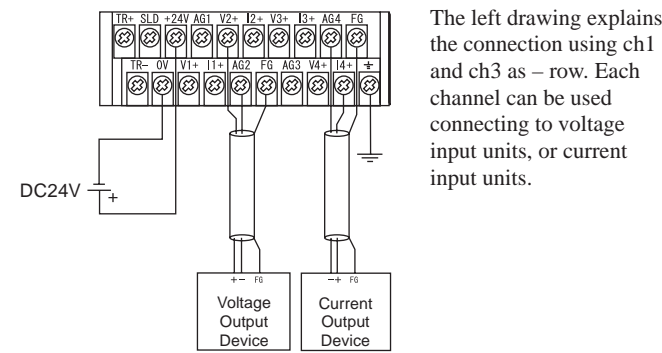

The left drawing explains the connection using ch1 and ch3 as - row. Each channel can be used connecting to voltage input units, or current input units.

Ch 1 output voltage terminals V1+, AG1, FG
Ch 1 output current terminals I1+, AG1, FG

Input Circuit Drawing

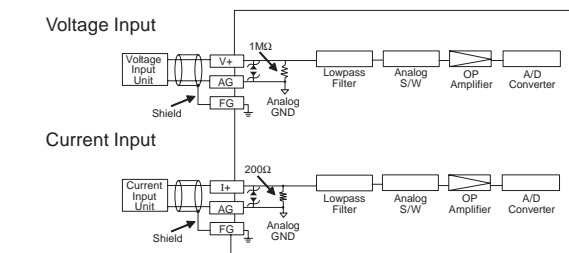

- Note:** The analog unit's power supply should be separated from the sensor's power supply to prevent the unit from being affected by external noise.
- Use Two FG terminals with 4 channels, and use one FG terminal with 2 channels.

To Prevent Unit Damage

- Do not store or operate this unit in either direct sunlight or excessively dusty or dirty environments.
- Since this unit is a precision instrument, do not store or use it in locations where excessive shocks or vibration may occur.
- Do not block this unit's ventilation holes, or operate it in an environment that may cause it to overheat.
- Do not operate this unit in locations where sudden temperature changes can cause condensation to form inside the unit.
- Do not use paint thinner or organic solvents to clean this unit.

Package Contents

- Flex Network 4 Channel Analog/Digital Conversion Unit (FN-AD04AH11)
- Flex Network 4 Channel Analog/Digital Conversion Unit Installation Guide (this guide)

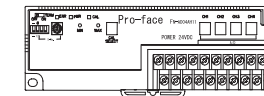

Driver & Manual

The driver for the Flex Network Unit is required in order to use the unit. For GLC2000 Series and LT Series, You can select the Flex Network Driver via GP-PRO/PBIII C-Package (Pro-Control Editor) or LT Editor. If the selection of the appropriate unit's name does not appear in the [I/O Configuration] - [I/O Unit Settings] area, you will need to update the driver file. You can download the latest driver from Pro-face's Home Page. For GP3000 Series, You can select the Flex Network Driver via GP-Pro EX as an I/O driver.

Also, you can download the driver and the Flex Network Analog Unit User Manual from Pro-face's web site. (<http://www.pro-face.com/>)

4 Installation

Installing the unit on a 35 mm DIN Rail:

- Installation**
Hook the analog unit's top face groove over the top edge of the DIN rail. Next, push the bottom of the I/O unit forward until the attachment hook clicks into place on the DIN rail.
- Removal**
Use a screwdriver to push the attachment hook down and release the unit. Then, pull the unit forward and off the rail.

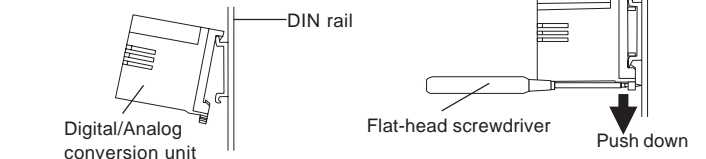

Important Be sure that the top and bottom faces of the unit are facing the correct direction and the unit is installed in a vertical position. Incorrect installation may prevent heat from dissipating.

Installing the unit in a Panel

Create installation screw holes for installing the unit using the dimensions given below. Secure the analog unit in place with M4 size screws. Screw torque should be 1.0 to 1.3 N·m. (Unit: mm [in.])

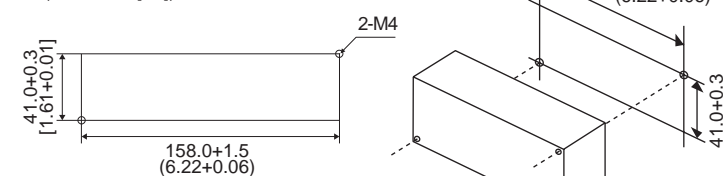

5 Wiring

This section describes both the cables and crimp terminals used for wiring each type of cable. The terminal screw torque should be 0.6 to 1.0 N·m.

1 External Dimensions / Part Names

This section shows the external dimensions of the analog/digital conversion unit, part names and part settings.

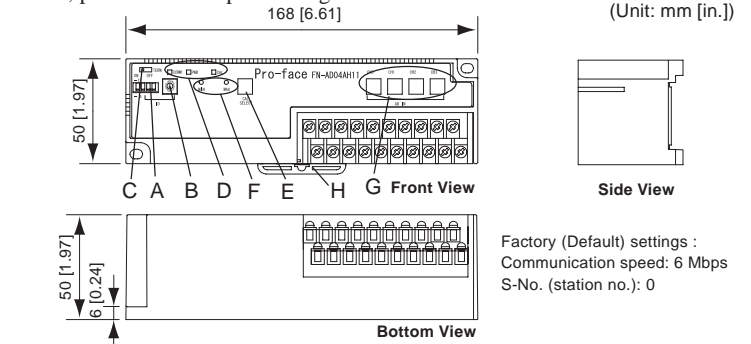

- A: Dip Switch Set communication speeds and S-No. (first digit).
- B: S-No. (station no.) Switch Sets S-No. (last digit).
- C: Terminator Switches termination ON/OFF. Turns ON the units at both ends of the communication cable.
- D: Status LED Indicates the unit's current operation status.
- E: Calibration Select Switch Selects a calibration setting. Refer to "Table 1".
- F: Calibration Perform Switch Pushing this switch performs calibration of the AD input's lower limit value (MIN), upper limit value (MAX).
- G: Range Switch Switches a range setting. Refer to "Table 2".
- H: DIN Rail Attachment Hook is used to attach the unit to a DIN rail

Select SW Setting	Calibration
1	CH1- AD Lower / Upper Limit Values Setting
2	CH2- AD Lower / Upper Limit Values Setting
3	CH3- AD Lower / Upper Limit Values Setting
4	CH4- AD Lower / Upper Limit Values Setting
0, 5 to F	Disabled (*1)

Range SW Setting	Range
0	0V - 5V (*1)
1	1V - 5V
2	0V - 10V
3	-5V - 5V
4	-10V - 10V
5	0 - 20mA
6	4 - 20mA
7 to F	Disabled

*1: The factory setting is "0".

*1: The factory setting is "0 (0 to 5V)".

Switch Settings

- SW1 Reserved
- SW2 6 - 6 Mbps, 12 - 12 Mbps
- SW3, 4 UP - ON (1) Down - OFF (0)
- Arrow tip Setting values (0 to F)
- OFF Termination OFF
- ON Termination ON

Examples of S-No. (station no.) settings

S-No.	Dip Switch SW3	Dip Switch SW4	S-No. (Station no.)
10h(16)	OFF(0)	ON(1)	0
3Fh(63)	ON(1)	ON(1)	F

Communication Cable

The Flex Network interface and the analog unit, or all distributed analog units, are connected using a cross wiring system. (T-type systems cannot be used.) Pro-face suggests the following communication cables.

Distributor	Order Code	Length
Pro-face	FN-CABLE2010-31-MS	10m
	FN-CABLE2050-31-MS	50m
	FN-CABLE2200-31-MS	200m

When preparing the cable wire ends:

- Cover shielded wires with shield tape or with an insulation tube.
- Use insulated crimp terminal.
- If you use a pressure connection terminal without insulation, cover it with a shield tape or an insulation tube. Cover uninsulated crimp terminals with shield tape or a tube-type insulation.

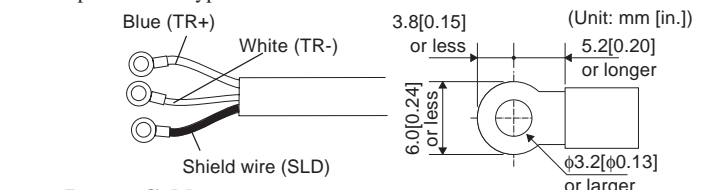

Power Cable

- Cable diameter can be up to 1.25 mm². Be sure to twist all wire ends before attaching crimp terminals.
- Use the same type crimp terminals as used for the communication cable.

Analog Input Cable

- Cable diameter can be up to 0.9 mm². (CPEV-S φ up to 0.9mm - 2 core, shielded)
- Use the same type crimp terminals as used for the communication cable.

Important Confirm that all I/O unit terminal screws are securely tightened, even they are not used.

Note Please be aware that Digital Electronics Corporation shall not be held liable by the user for any damages, losses, or third party claims arising from the uses of this product.

Digital Electronics Corporation
8-2-52 Nanko-higashi
Suminoe-ku, Osaka 559-0031 JAPAN
Tel: +81-(0)6-6613-1101
Fax: +81-(0)6-6613-5888
URL: <http://www.proface.com.jp/>

©Copyright 2000 Digital Electronics Corporation. All rights reserved.